

Slate

Kitchen Mixer

Article no.: 650870000

Finish: Chrome

Series: Slate

VVS no.:

EAN no.:

5708516807599



Standard features:

- Ceramic cartridge
- Scalding protection (38°C)
- Swivel spout
- 120° swivel limitation
- Rub-clean aerator
- Cold-start
- Eco-Save water saving feature
- 1 handle

Product features

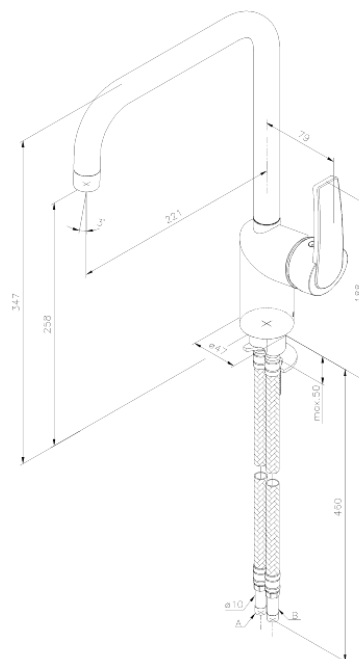

FM Mattsson Mora Group Denmark
Abildager 26 A, 2605 Brøndby, Denmark
Østbirkvej 2, 5240 Odense NØ, Denmark

+45 63 10 22 10 danmark@fmm-mora.com

For more information please visit www.damixa.com

damixa